



COMPANY PROFILES



“Our vision is to be an organization of **QUALITY SKILLS & SERVICES** for the wide spectrum of Construction industry, Oil & Gas, & Maritime.

Phuc Loc Phat Petroleum Services Company Limited

(Phuc Loc Phat):

Head office & Workshop: No. 973, 30/4 Road, Ward 11, VungTau city, S.R Vietnam

Tel: +84 2543586 268

Fax: +84 2543586 268

Hotline: +84 931 858688

Email: info@phuclocphatltd.com

Website: [www.https://phuclocphatltd.com](https://phuclocphatltd.com)





We supply highly skilled technical human resources (Crews, engineers, welders, fitters, mechanics, etc.) at the demand of domestic and international partners.



We provide advanced and innovative marine and port project solutions for the support and development of the maritime industry.



We provide advanced and innovative project solutions for the support and development of the regional and local onshore and offshore oil and gas industry.

About Us

Phuc Loc Phat Petroleum Services Company Limited (Phuc Loc Phat) provide high quality advisory and development services in Construction industry, Marine & Oil-Gas industry (Fabrication and Installation Structure, Piping & Mechanical, E&I... for Oil & Gas; Modification and maintenance services, Supply services equipment for construction, Materials supply etc...). Specially, **Phuc Loc Phat** supply highly skilled technical human resources (Crews, engineers, welders, fitters, mechanics, etc...) at the demand of domestic and international partners.

Head office & Workshop: No. 973, 30/4 Road, Ward 11, VungTau city, S.R Vietnam

Tel: +84 2543586 268 Fax: +84 2543586 268

Hotline: +84 931 858688

Email: info@phuclocphatltd.com

Website: [www.https://phuclocphatltd.com](https://phuclocphatltd.com)

Contact person:

Mr. Nguyen Quang Thi- CEO

Email: thinq@phuclocphatltd.com

Phone: 0931 85 86 88

Mr. Duong Minh Vu – Director

Email: vudm@phuclocphatltd.com

Phone: 0901 348 888

Company Vision & Mission

VISION

To be an organization of **QUALITY SKILLS & SERVICES** for the wide spectrum of Construction industry, Oil & Gas, as well as Maritime.

MISSION

“To provide the *best in class services*, **maximizing value** for customer, being a **reliable partnership** in the Industry”



Organization Chart

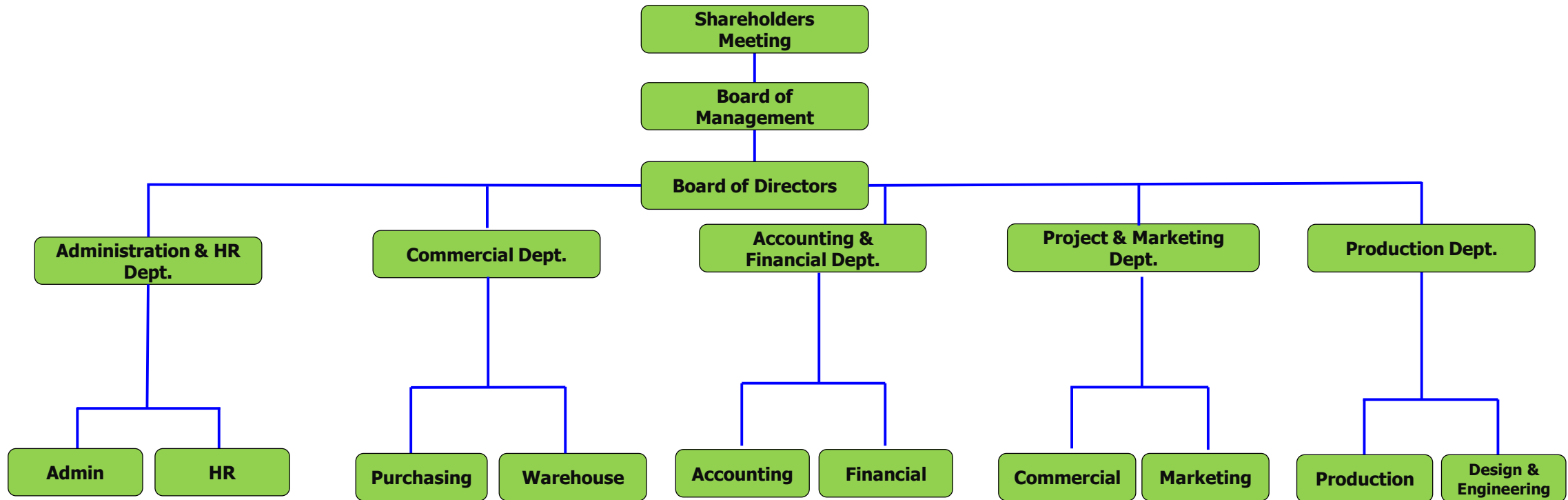

Legal Company Profiles

Certificate of business registration

SỞ KẾ HOẠCH VÀ ĐẦU TƯ
TỈNH BÀ RỊA - VŨNG TÀU
PHÒNG ĐĂNG KÝ KINH DOANH

CỘNG HÒA XÃ HỘI CHỦ NGHĨA VIỆT NAM
Độc lập – Tự do – Hạnh phúc

**GIẤY CHỨNG NHẬN ĐĂNG KÝ DOANH NGHIỆP
CÔNG TY TRÁCH NHIỆM HỮU HẠN HAI THÀNH VIÊN TRỞ LÊN**

Mã số doanh nghiệp: 3502384757

Đăng ký lần đầu: ngày 08 tháng 01 năm 2019

Đăng ký thay đổi lần thứ: 8, ngày 30 tháng 09 năm 2024

1. Tên công ty

Tên công ty viết bằng tiếng Việt: CÔNG TY TNHH DẦU KHÍ PHÚC LỘC PHÁT

Tên công ty viết bằng tiếng nước ngoài:

Tên công ty viết tắt:

2. Địa chỉ trụ sở chính

Số 973 Đường 30/4, Phường 11, Thành phố Vũng Tàu, Tỉnh Bà Rịa - Vũng Tàu, Việt Nam

Điện thoại: 02543.586268

Email: info@phuclocphatltd.com

Fax: 02543.586268

Website:

3. Vốn điều lệ : 6.000.000.000 đồng.

Bằng chữ: Sáu tỷ đồng

4. Danh sách thành viên góp vốn

STT	Tên thành viên	Quốc tịch	Địa chỉ liên lạc đối với cá nhân; địa chỉ trụ sở chính đối với tổ chức	Phần vốn góp (VNĐ và giá trị tương đương theo đơn vị tiền nước ngoài, nếu có)	Tỷ lệ (%)	Số Giấy tờ pháp lý của cá nhân; Mã số doanh nghiệp đối với doanh nghiệp; Số Giấy tờ pháp lý của tổ chức	Ghi chú
1	ĐOÀN THỊ THANH	Việt Nam	Phòng B1204, chung cư Lakeside B, Phường Nguyễn An Ninh, Thành phố Vũng Tàu, Tỉnh Bà Rịa - Vũng Tàu, Việt Nam	2.880.000.000	48,000	033187000499	

2	LÊ VĂN LONG	Việt Nam	971 Tôn Thất Thuyết, Phường 01, Quận 4, Thành phố Hồ Chí Minh, Việt Nam	1.680.000.000	28,000	038059008938	
3	DƯƠNG MINH VŨ	Việt Nam	A75/6E/15 đường Bạch Đằng, Phường 2, Quận Tân Bình, Thành phố Hồ Chí Minh, Việt Nam	1.440.000.000	24,000	045071008242	

5. Người đại diện theo pháp luật của công ty

* Họ và tên: DUƠNG MINH VŨ

Giới tính: Nam

Chức danh: Giám đốc

Sinh ngày: 10/01/1971

Dân tộc: Kinh

Quốc tịch: Việt Nam

Loại giấy tờ pháp lý của cá nhân: Thẻ căn cước công dân

Số giấy tờ pháp lý của cá nhân: 045071008242

Ngày cấp: 29/07/2022

Nơi cấp: Cục trưởng cục cảnh sát QLHC về trật tự xã hội

Địa chỉ thường trú: A75/6E/15 đường Bạch Đằng, Phường 2, Quận Tân Bình, Thành phố Hồ Chí Minh, Việt Nam

Địa chỉ liên lạc: A75/6E/15 đường Bạch Đằng, Phường 2, Quận Tân Bình, Thành phố Hồ Chí Minh, Việt Nam

TRƯỞNG PHÒNG



Nguyễn Văn Trường

Workforce

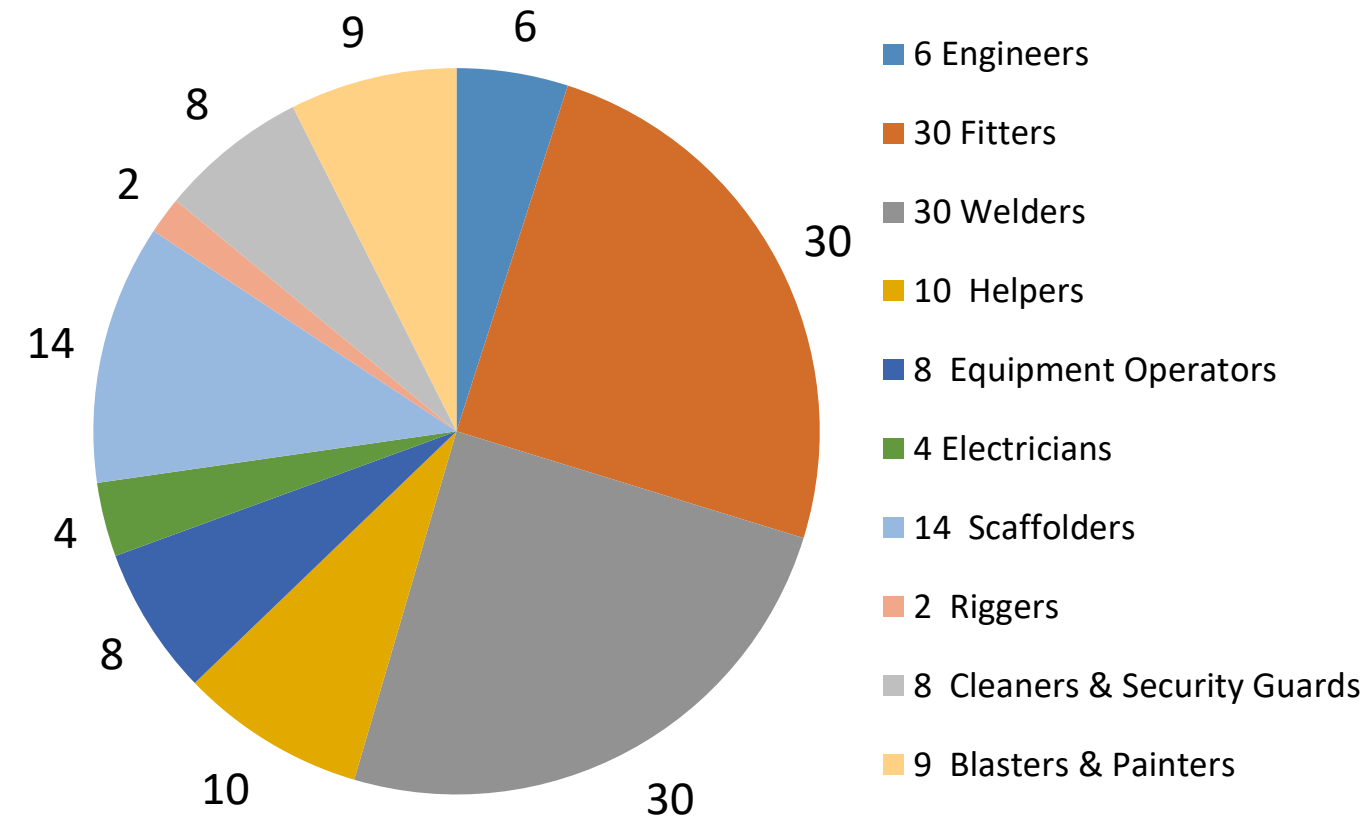

Total number of employees: 120+



WORKSHOP/YARD

Premises / Equipment

- Location: Vung Tau city, S.R Vietnam
- Fabrication area: 5 ha
- Water depth: 7.0 – 9.0m
- Jetty length: 142.0m
- Jetty designed for 10,000 DWT Vessels
- Jetty distribution: Max 50 MT/m²
- Yard distribution: Max 35 MT/m²
- Average production capacity: up to 40,000 MT per year



Yards & Workshops



Equipment Capability

No.	Name of Equipment (MAIN)	Quantity	Capacity	Feature	Original	Production Year	Status
1	Ultra High Pressure (UHP) 2500 bar	1	2500 bar	Sugino	Japan	2011	good
2	Ultra High Pressure (UHP) 2500 bar	1	2500 bar	Uraca	German	2012	good
3	Ultra High Pressure (UHP) 2500 bar	1	2500 bar	Hammermal	German	2010	good
4	TIG Welding Machine	10	200-500A	JASIC	VN/China	2020	good
5	SMAW/FCAW Welding Machine	6	200-500A	JASIC	VN/China	2020	good
6	Air compressor	2	130-250CFM	HITACHI	Japan	2015	good
7	Air compressor	4	130-250CFM	DENYO	Japan	2012	good
8	Painting machine	5	45/60 bar	HK63	Korea	2021	good
9	Grinding machine	20		MIKITA	Japan	2020	good
10	Chipping machine	18		JET-CHISEL	Japan	2020	good
11	CNC cutting machine	2		2mx6m	VN	2015	good
12	Hydraulic jack	4	100 T	OSAKA	Japan	2009	good
13	Truck (Rent)	2	3.5T	IZUSU	Japan	2010-2011	good
14	Forklift (Rent)	2	5-7T	HYSTER	U.S.	2011	good

Equipment Capability

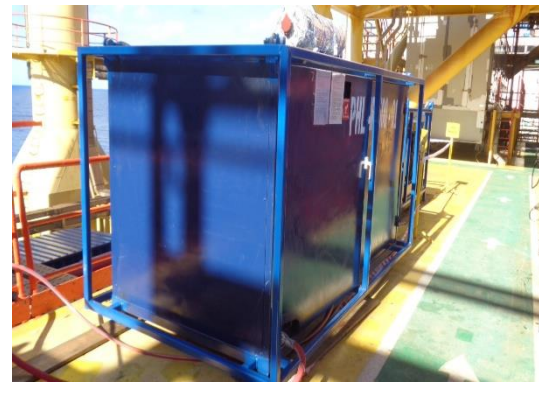

Equipment Capability

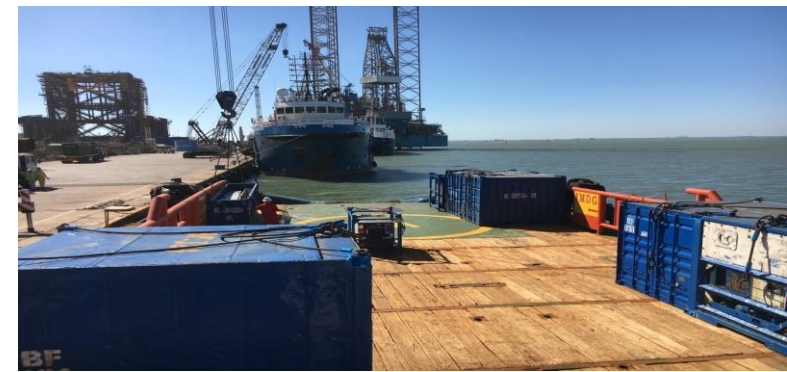
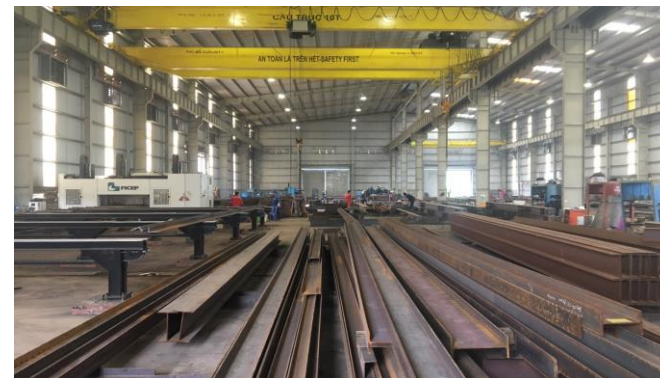

Construction & Build Works

We do the Construction & Build Works inclusive of:

- Construction consultancy contract
- Engineering – Construction (EC contract)
- Engineering - Procurement – Construction (EPC Contract)
- Engineering – Procurement (EP)
- Turnkey contract
- Contract to supply manpower, construction machines and equipment
- Civil engineering
- Electrical
- Insulation for tank/pipe line system
- Water system/pipeline system
- An-ti corrosion control

Construction & Build Works



Mechanical Fabrication Services

We do the mechanical fabrication for:

- Hull block fabrication...
- Piping spool fabrication/installation
- Beam and structure, Skid fabrication
- Offshore containers, gas racks, long-basket fabrication...
- Steel structure & piping fabrication productivity:
- Steel structure fabrication/Piping fabrication...

Mechanical Fabrication Services

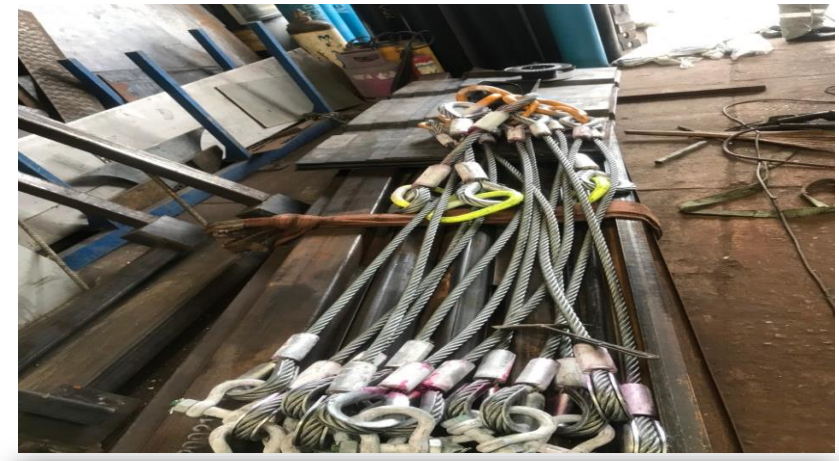

Construction of insulation for piping systems and equipment



Piping fabrication & Installation Services



FPSO BUMI ARMADA TGT1

- *Project: Fabrication & Offshore installation for piping system*
- *Client : BUMI ARMADA BE HAD*
- *Location: Offshore Vietnam*

Long Phu 1 Thermal Power Plant

- *Project: Cooling Water Pipe installation for Long Phu 1 Thermal Power Plant*
- *Client : PTSC Long Phu*
- *Location: On-shore Vietnam*

Piping fabrication



A1 Package - Long Son Petrochemical Plant

- *Project: Shop Piping fabrication for A1 Package - Long Son Petrochemical Plant*
- *Client : TPSK/PTSC Quang Ngai*
- *Location: On-shore Vietnam*

Piping fabrication



- *Project: Spool fabrication for FPSO PTSC Lam Son; FPSO RUBY II*
- *Client : PTSC PS*
- *Location: On-shore Vietnam*

FPSO/FSO Hull/Tanks repair Services



- *Project: FPSO RUBY II*
- *Client : PTSC PS*
- *Location: Offshore Vietnam*

FPSO/FSO Hull/Tanks repair Services



- *Project: FPSO RUBY II*
- *Client : PTSC PS*
- *Location: Offshore Vietnam*

Flare Tower Structure repair Services

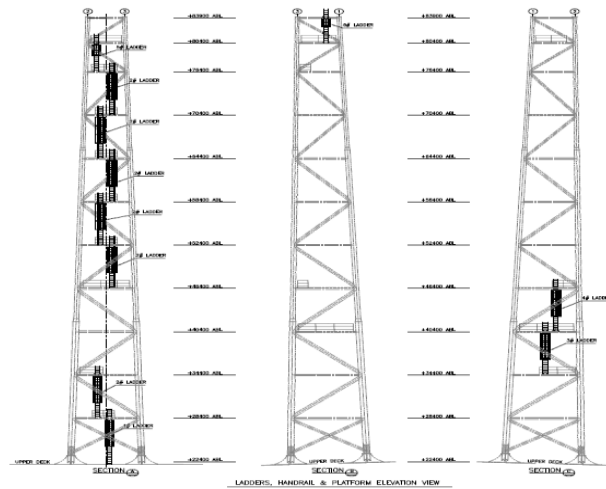

- *Project: FPSO RUBY II*
- *Client : PTSC PS*
- *Location: Offshore Vietnam*

Anti-corrosion services



CUU LONG CPP Platform

- *Project: Provision of Painting Services for CUU LONG Platform*
- *Location: Offshore Vietnam*

Anti-corrosion services



FPSO RUBY II

- *Project: Provision of Painting Services for FPSO RUBY II*
- *Location: Offshore Vietnam*
- *Owner: PTSC PS*

Anti-corrosion services



FPSO PTSC LAM SON

Project: Provision of Painting Services for PTSC LAM SON

- *Location: Offshore Vietnam*
- *Owner: PTSC PS*

Anti-corrosion services



FSO GOLDEN STAR

Project: Provision of Painting Services for GOLDEN STAR

- *Location: Offshore Vietnam*
- *Owner: PTSC PS*

Anti-corrosion services



FSO PTSC BIENDONG 01

Project: Provision of Painting Services for FSO PTSC BIENDONG 01

- *Location: Offshore Vietnam*
- *Owner: PTSC PS*

Anti-corrosion services



CCP SU TU VANG CUU LONG JOC

Project: Provision of Painting Services for CCP SU TU VANG CUU LONG JOC

- *Location: Offshore Vietnam*
- *Owner: CUU LONG JOC*

Anti-corrosion services



TBDP-A THAI BINH PETRONAS

Project: Provision of Painting Services for TBDP-A THAI BINH

- *Location: Offshore Vietnam*
- *Owner: PETRONAS VIETNAM*

Insulation fabrication & Installation



- *Project: PETROCHEMICAL COMPLEX IN SOUTH OF VIETNAM*
- *Client : Siam Cement Group (Thailand)/Manh Thang Co.,Ltd*
- *Location: On-shore Vietnam*

- *Project: MODULAR Sox SCRUBBER RETROFIT*
- *Client : WARTSILA*
- *Location: On-shore Vietnam*

Insulation fabrication & Installation



- *Project: FPSO RUBY II*
- *Client : PTSC PS*
- *Location: Offshore Vietnam*

- *Project: FPSO PTSC LAM SON*
- *Client : PTSC PS*
- *Location: Offshore Vietnam*

Insulation fabrication & Installation



- *Project: FSO GOLDEN STAR*
- *Client : PTSC PS*
- *Location: Offshore Vietnam*

- *Project: FSO PTSC BIENDONG 01*
- *Client : PTSC PS*
- *Location: Offshore Vietnam*

Welding Habitat Services

OVERVIEW OF HABITAT SYSTEM

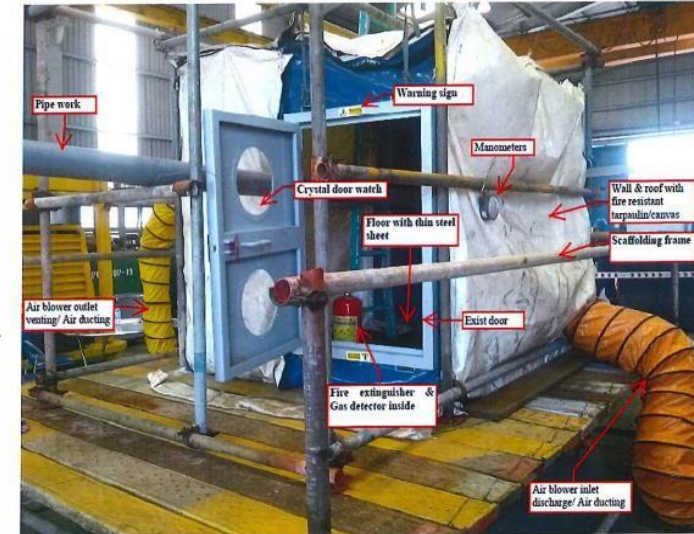
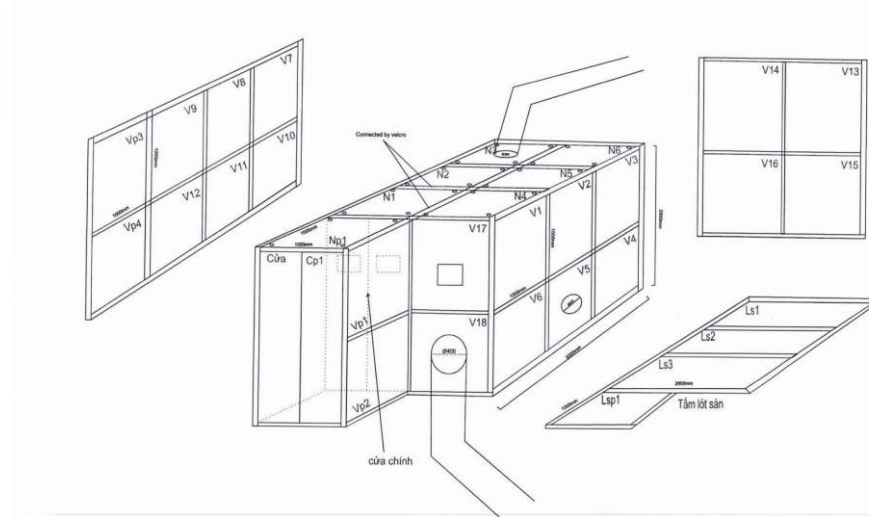
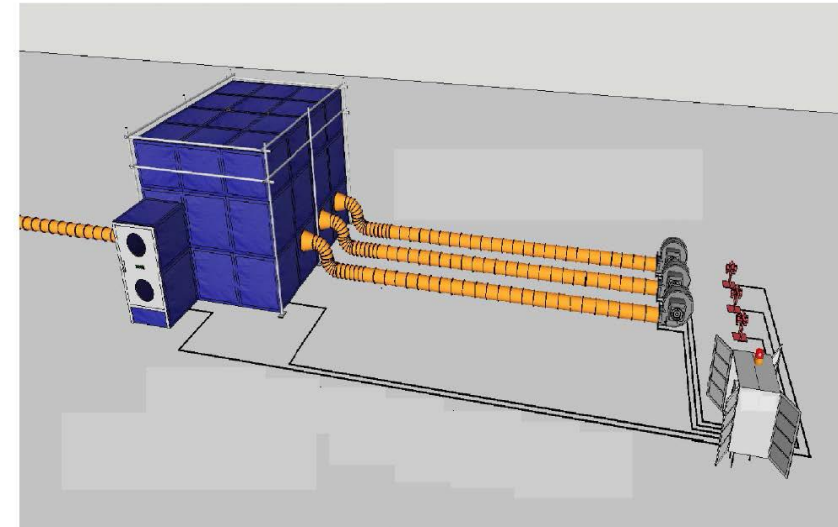

Pressurized Habitats sample

We providing all pressurized habitats (with dimension maximum of 5m length x 4m width x 3m height) for the hot work offshore installation in FPSO/WHP repair Projects. Hot work was planned at offshore installation of new piping/ structural steel whilst the plant is still in operation which mandatory to be complied with Client safety requirement.

Welding Habitat Services

CÔNG TY CP ĐÀO TẠO VÀ HUẤN LUYỆN AN TOÀN DẦU KHÍ VIỆT NAM -
CHI NHÁNH VŨNG TÀU
PETROVIETNAM SAFETY TRAINING AND EDUCATION JS COMPANY -
VUNG TAU BRANCH

SAFE
PVS TRAINING

GIẤY CHỨNG NHẬN / CERTIFICATE
Xác nhận / This is to certify that

Ông/Bà: **LÊ VĂN HỢI**
Mr/Ms: **LE VAN HOI**
Ngày sinh /Day of birth: **20/08/1985**
Quốc tịch/Nationally: **Việt Nam**
Đã hoàn thành khóa học/Have completed the course

PVS HABITAT
SAFETY WORKING APPLIANCE TECHNOLOGY

Kết quả/Result: **Đạt yêu cầu**
Xếp loại/Classification: **Khá**

Thời gian học: Từ ngày 11/05/2023 đến ngày 13/05/2023
Date course: From May 11 2023 to May 13 2023

Ngày cấp/ Issued date: **13/05/2023**
Ngày hết hạn/ Expiry date: **13/05/2025**
Số chứng nhận/ Cer no: **010/2023/HAB**

LE NGOC TU
Trainer/instructor

NGUYEN HONG THUONG
Training/ Operation Manager

CÔNG TY CP ĐÀO TẠO VÀ HUẤN LUYỆN AN TOÀN DẦU KHÍ VIỆT NAM -
CN VŨNG TÀU
PETROVIETNAM SAFETY TRAINING AND EDUCATION JS COMPANY

SAFE
PVS TRAINING

GIẤY CHỨNG NHẬN / CERTIFICATE
Xác nhận / This is to certify that

Ông/Bà: **NGUYEN THAO ANH**
Mr/Ms: **NGUYEN THAO ANH**
Ngày sinh /Day of birth: **19/10/1996**
Quốc tịch/Nationally: **Việt Nam**
Đã hoàn thành khóa học/Have completed the course

PVS HABITAT
SAFETY WORKING APPLIANCE TECHNOLOGY

Kết quả/Result: **Đạt yêu cầu**
Xếp loại/Classification: **Khá**

Thời gian học: Từ ngày 12/12/2022 đến ngày 14/12/2022
Date course: From Dec 12th 2022 to Dec 14th 2022

Ngày cấp/ Issued date: **16/12/2022**
Ngày hết hạn/ Expiry date: **16/12/2024**
Số chứng nhận/ Cer no: **011/2022/HAB**

LE NGOC TU
Trainer/instructor

NGUYEN HONG THUONG
Training/ Operation Manager

CÔNG TY CP ĐÀO TẠO VÀ HUẤN LUYỆN AN TOÀN DẦU KHÍ VIỆT NAM -
CN VŨNG TÀU
PETROVIETNAM SAFETY TRAINING AND EDUCATION JS COMPANY

SAFE
PVS TRAINING

GIẤY CHỨNG NHẬN / CERTIFICATE
Xác nhận / This is to certify that

Ông/Bà: **ĐÀO NAM BẮC**
Mr/Ms: **DAO NAM BAC**
Ngày sinh /Day of birth: **13/02/1994**
Quốc tịch/Nationally: **Việt Nam**
Đã hoàn thành khóa học/Have completed the course

PVS HABITAT
SAFETY WORKING APPLIANCE TECHNOLOGY

Kết quả/Result: **Đạt yêu cầu**
Xếp loại/Classification: **Khá**

Thời gian học: Từ ngày 12/12/2022 đến ngày 14/12/2022
Date course: From Dec 12th 2022 to Dec 14th 2022

Ngày cấp/ Issued date: **16/12/2022**
Ngày hết hạn/ Expiry date: **16/12/2024**
Số chứng nhận/ Cer no: **012/2022/HAB**

LE NGOC TU
Trainer/instructor

NGUYEN HONG THUONG
Training/ Operation Manager

The hot-work habitats shall be designed, constructed, operated & maintained by Hai Quang T&C Co., Ltd. and to cooperate with Client and ensure the habitats are correctly built and subsequent hot work are carried out safely and efficiently.

Design & Engineering

- Construction design
- Structural Drawing. ...
- Electrical Drawing. ...
- Plumbing Drawing. ...
- Finishing Drawings.
- 3D SOLID Modelling by AutoCAD

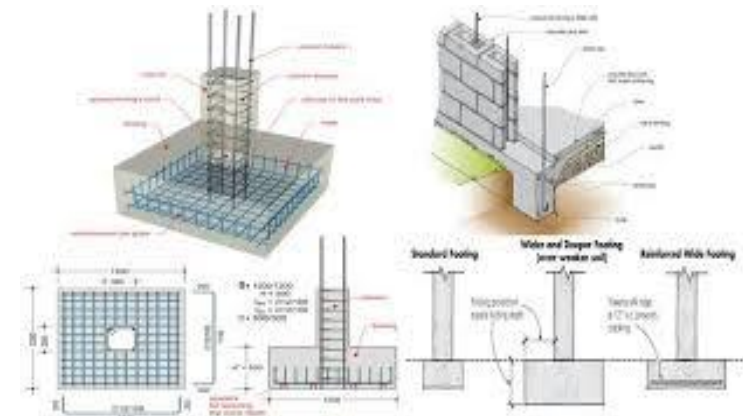
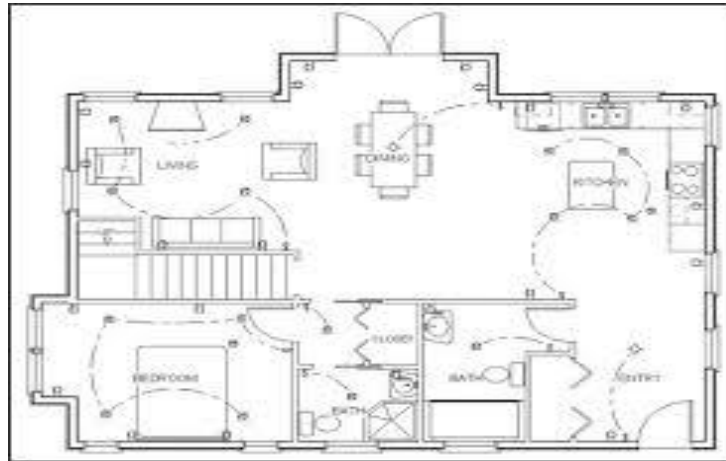

Other Services

Other services

- Oil & Gas equipment trading
- Shipping agency, visas, accommodation
- Container manufacture and supply: office/diving/cargo container...
- Consumable, fuel supply (oxy, acetylene, gases, welding wires, diesel...)



Vessel/Barge Supply/Logistic Services

- Towing/escort Lift-boat, vessel, barges, jack-ups doing jetty shifting /sea trial...
- Provide supply boat cargoes, manpower transportation to Rig, anchorage...
- Provide guard boat for guard duties at offshore
- Transportation of container/equipment/ personnel



Vessel/Barge Supply/Logistic Services

- Bunkering/berthing/towing services
- Provide deck- barge, flat top barge, AHTS vessel, DP vessel...
- Heavy lift/ Long haul services



Providing Wooden products

Provide wooden products of:

- Wooden Pallet
- Wooden lining of many sizes
- Wooden crates...



Providing Rubber Products

- Provide Airbags for ship launching
Type 1: D1.8m x L19m x 9 layers (breaking pressure: 9.1 Mpa)
Type 2: D1.5m x L15m x 6 layers (breaking pressure: 4.5 Mpa)
- Provide Fenders
Working pressure : 0.05 Mpa Testing pressure : 0.15 Mpa
- Custom rubber solutions for marine & offshore industry.

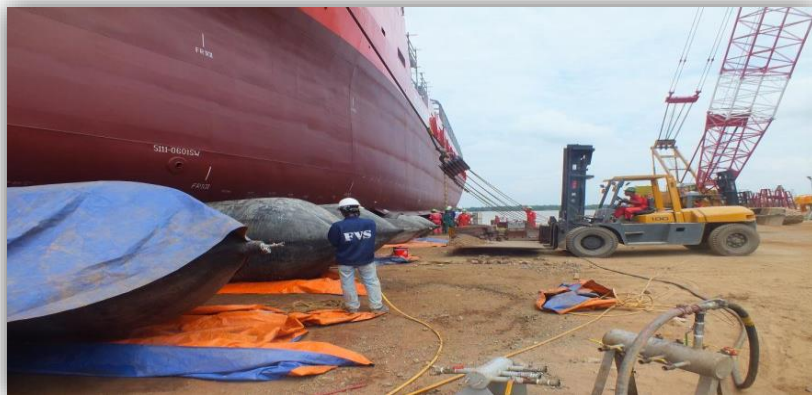

Other services

- Oil & Gas equipment trading
- Shipping agency, visas, accommodation
- Container manufacture and supply: office/diving/cargo container...
- Consumable, fuel supply (oxy, acetylene, gases, welding wires, diesel...)
- Providing equipment and industry materials.

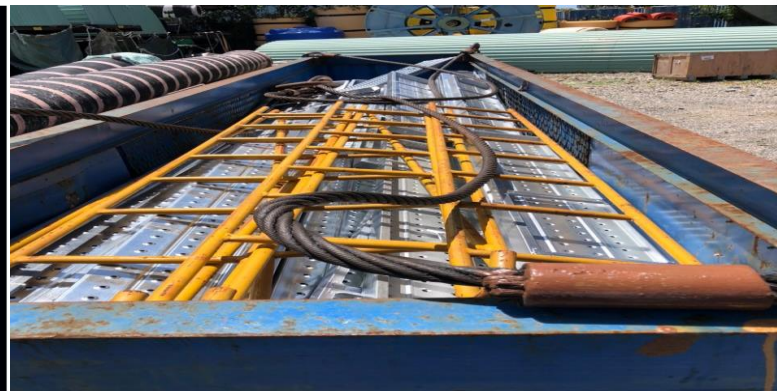

Clients & Partners



PLEASE CONTACT US FOR YOUR VALUABLE INQUIRIES

Head office & Workshop: No. 973, 30/4 Road, Ward 11, VungTau city, S.R Vietnam

Tel: +84 2543586 268 Fax: +84 2543586 268

Hotline: +84 931 858688

Email: info@phuclocphatltd.com

Website: [www.https://phuclocphatltd.com](https://phuclocphatltd.com)

Contact person:

Mr. Nguyen Quang Thi- CEO Email: thinq@haiquangtc.com

Phone: 0931 85 86 88